

RULES, REGULATIONS AND JUDGING STANDARDS
OF THE

INTERNATIONAL FANCY GUPPY ASSOCIATION

FOR SHOWING FANCY GUPPIES

TABLE OF CONTENTS

Section I – Shows	Page
Point Shows-----	1
Definition-----	1
Open Competition-----	1
Show Dates-----	1
Cancellation of Shows-----	1
Approval of Classes-----	1
Show Results-----	1
Complaints-----	1
Non-Point Shows-----	2
Section II – Required Show Classes	
Point Shows-----	3
Non-Point Shows-----	3
Junior Class/Novice Class-----	3
Section III – Entries-----	4
Section IV – SetUp	
Tanks and Bowls-----	5
Backgrounds-----	5
Lights-----	5
Water-----	5
Section V – Judging and Awards	
Judging Teams-----	5
Recommended Awards-----	5
Shipment of Awards-----	5
Section VI – Championship Awards	
Point Accumulation & Computation-----	6
Basic Points-----	6
Penalties-----	6
Section VII – IFGA Accredited Judges	
Accreditation Requirements-----	7
Judging Tests-----	7
Judging Seminars-----	7
Retention of Accreditation-----	7
Loss of Accreditation-----	7
Reinstatement-----	8

Section VIII – Changes to Judging Standards -----	8
Section IX – Classification of Entries	
Color Strains-----	8
Classification of Show Entries-----	8
Color Varieties-----	9
Color Clarification-----	9
Classification by Caudal Shape-----	9
Section X – Point System for Judging	
Point System (Males)-----	10
Tank and Breeder Entries-----	10
Disqualifications-----	10
Point System (Females)-----	10
Section XI – Judging Standards for Types of Guppies	
Delta Tail Guppy-----	11
Veil Tail Guppy-----	12
Sword Tail Guppy-----	13
Female Guppy-----	14
Section XII - Judging the Male Guppy (<i>Articles by Stan Shubel</i>)	
<u>Body</u>	
Size-----	15
Shape-----	15
Condition-----	16
Color-----	16
Deformity-----	17
<u>Dorsal</u>	
Shape-----	18
Size-----	18
Color-----	19
Condition-----	19
<u>Caudal</u>	
Shape-----	20
Color-----	23
Size-----	24
<u>Department</u> -----	26
<u>Symmetry</u> -----	26
Section XIII - Judging the Female Guppy (<i>Articles by Tom Allen & Stan Shubel</i>)	
Classification of Female Guppies-----	27
Body-----	28
Caudal-----	29
Dorsal-----	30
Department-----	31
Symmetry-----	31
Section XIV – Matching Points (<i>Article by Paul Gorski</i>)	32

Note: The Information in this booklet is the sole property of the International Fancy Guppy Association. Copies may not be made without prior permission of the Board of Directors of the IFGA.

SECTION I – SHOWS

All IFGA sanctioned shows must follow the rules, regulations, and standards set up by the IFGA and must have an accredited IFGA judge in attendance. In the absence of a senior judge, the ranking judge (lowest card number) will be in charge of the show during the time of judging, defined as the time from after the audit of entry classes until all Bests of Show are selected. He will also have the authority to remove what he considers to be a sick fish from the show room and to administer the judging with the authority of the Judging Board. Failure by a club to comply with all required rules and regulations will result in that club having its IFGA rights and privileges revoked.

There are two types of IFGA shows: point shows and non-point shows. Point shows are limited in number per year, and may be held only by IFGA member clubs on a rotation basis. Non-point shows may be held by non-IFGA clubs as well as by member clubs. There is no limit on the number of non-point shows that may be sanctioned in a year.

POINT SHOWS

Definition of a Point Show: A point show is one at which members may earn points toward annual IFGA championship awards. The number of points earned for each place won is noted in Section VI. Total points earned are based upon two factors: 1) the basic established point system and 2) the point value of the show. Because all shows require over 65 classes, all point shows will be categorized as 10-point shows.

Open Competition: Competition is open to any exhibitor, whether a member of the IFGA or not, as long as the exhibitor abides by all IFGA rules and regulations.

Show Dates: The show schedule is to be allotted during the year by electronic means (telephone and internet discussion), and submitted for approval at the Annual Meeting. All Show Chairs for approved sanctioned point shows of the year must request their show dates within the time specified by the Show Rotation Chair, if the date was not set at the time of the Annual Meeting. If one or more clubs combine to put on a point show, the show must be held in the same state or province in which the club that qualifies for the show is located. In the event there is not a show scheduled in October, the IFGA may schedule the Annual Meeting and show anytime between 30 days after the last show and the first weekend in November.

Cancellation of a Point Show: Any club that cancels a sanctioned scheduled point show will be fined \$50.00 and miss its place for three show rotations.

Approval of Show Classes: The IFGA has established a list of basic show classes that are required at all IFGA point shows. (See Required Show Classes, Section II.) The show announcement (to include a list of all show classes) must be sent via the web-site to the Judging Board for approval, 90 days prior to the show date. Any club failing to do so within the time limit is subject to a \$50.00 fine that must be paid before it will be given another show. When the list of show classes is approved by the Judging Board, it will be returned, with notice of approval, to the Show Chair and to the Webmaster.

Show Results: Results from a point show must be sent to the Awards Chair, the Judging Chair, and the Webmaster as soon as practical. Show results are to be submitted using the official show result e-format file. This includes a list of the judges, assistant judges, and observers; the number of entries in the show; the color classes of the Best of Show winners; and the number of entries in each class. Any disqualifications that may show up in the first through fourth places are also to be listed on this form.

Complaints About Shows: When written complaints on the poor handling and return of fish or on general mismanagement of a show are received from the officers of three different clubs, the Judging Board will investigate. If it is found that there are legitimate grounds for these complaints, any points awarded to the host club's members at the show will be taken away.

NON-POINT SHOWS

Non-member IFGA clubs as well as IFGA affiliated clubs may hold sanctioned non-point shows, as long as all IFGA rules, regulations, and judging standards are followed. A sanction fee of \$30.00 is required of all non-affiliated clubs. There is no fee for an IFGA affiliated club. The following special rules apply to non-point shows:

- 1) The date of a non-point show is not to conflict with a regular IFGA point show.
- 2) The show must include the classes listed as mandatory for non-point shows (see Required Show Classes, Section II.)
- 3) There must be an accredited IFGA judge in attendance. The host club is to pay the judge's expenses, if any, if the person is invited to judge the show.
- 4) Show information must be mailed to the Secretary and the Editor at least 60 days prior to the show. The IFGA Website will list the following show information: name of club, date of show, location of show and the Show Chair's name and address. The sponsoring club is to assume all responsibility for further advertising. The IFGA Website will list complete show rules and results for a fee of \$10.00 for non-IFGA clubs.
- 5) Seminars and written testing may be conducted by any Senior Judge.
- 6) Non-point shows will count toward judge training requirements; therefore, a list of Judges, Assistant Judges and Observers actively involved in a particular show is to be sent to the Secretary, Awards Chair, Webmaster and Judging Chair within two weeks of the date of the show.

SECTION II – REQUIRED SHOW CLASSES

POINT SHOWS

The following are the required classes for an IFGA Point Shows. The minimum required classes dictate that all sanctioned shows will be 10 point shows.

SINGLE DELTA MALES/TANKS

Red	Red Bicolor
Blue	Bl/Gr Bicolor
Green	AOC Bicolor
Black	Multi
Purple	Solid Snakeskin
Yellow	Vari. Snakeskin
AOC	Swordtail
H/B Red	Red Albino
H/B Blue	AOC Albino
H/B Pastel	Gold
H/B Yellow	Bronze
H/B Purple	Novice
H/B Green	Junior
H/B AOC	

FEMALES

Red
AOC
H/B AOC
Bl/Green
Gold
Black
H/B Red
Bronze
Albino
Novice
Junior

VEILS (SINGLES)

All-Color Veil
Junior/Sword
Novice

BREEDER MALES

5 matched males, all colors combined

BREEDER FEMALES

3 matched females, all colors combined

Additional classes may be added at the discretion of the Show Chair; however, these classes will not earn IFGA class points or annual awards.

Items of Note:

- 1) Mandatory single male classes will be Delta and Veil. Non-mandatory additional classes may be Delta, Veil, or Delta/Veil combined.
- 2) All mandatory single delta classes must have a corresponding tank class (two matched males.)
- 3) All classes sponsored and voted on at the Annual meeting will become mandatory for the entire show year.
- 5) Breeder male and female classes may not be divided into separate color classes.
- 6) The All-Color Veil class will compete in Best of Show with deltas. The All-Color Veil winner will have the same points awarded as delta winners and applied to Grand Overall Male.

NON-POINT SHOWS

A non-point IFGA sanctioned show must include the following ten (10) classes:

Red	Blue	Green	Black	AOC	Half/Black	Bicolor
Snakeskin	Females (combined colors)			Two (2) Matched Males		

The classes may be Delta or Delta/Veil combined. Additional classes may be added as desired.

JUNIOR CLASSES

A junior exhibitor may exhibit in the Junior Class and is defined as anyone who is sixteen (16) years of age or younger at the time of the first show of the exhibition year. Placement in this class for annual awards does not preclude continued exhibition in the Junior Class.

NOVICE CLASS

A novice is defined as anyone who has not had a top two (2) placement in the annual awards (IFGA members only) in any class (including the Novice Class; excluding the Junior Class).

SECTION III – ENTRIES

Entry Requirements

- 1) All entries must be born and raised in the exhibitor's tanks.
- 2) The proper number of fish must be in a given entry.
 - Single entries: One male or one female. (A female is optional with the single male entries, but will not be judged.)
 - Tank Entries: Two matched males. (Females optional, but will not be judged.)
 - Breeder Male Class: Five (5) matched males that must conform to one of the IFGA recognized standards. (Females optional, but will not be judged.)
- 3) Fish must be alive to be judged.
- 4) All entries must be registered prior to the published closing time for accepting entries. Exceptions may not be granted.

Club Procedures for Handling of Entries

- 1) Proper care must be given to "shipped-in" entries.
- 2) Use of the IFGA approved computer entry worksheet is the preferred method for logging entries. As an alternative, a minimum of two entry books is recommended to speed up acceptance of entries.
- 3) All entries received DOA, or entries that die during the show, must be shipped back to the exhibitor in treated water to preserve the true marking, if the exhibitor so requests.
- 4) Should one fish of a tank entry die prior to benching, the committee must not enter it as a tank entry, but should enter the remaining fish as a single entry. The exhibitor must be reimbursed for the difference in the entry fee.
- 5) If a shipped in fish has been disqualified, the bowl tag giving the reason for the disqualification should be returned with the fish.
- 6) Shipped-in entries are to be returned to the exhibitor (by pre-paid method) as soon as possible after the show.
- 7) Chemical treatments or additives shall not be applied to any entry or entries that are not part of the club water treatment procedures for all entries. Chemical additives shall not be administered that could provide an advantage or disadvantage to any individual entry. **(11/2012)**

SECTION IV – SETUP

Tanks and Bowls:

- Clean tanks, bowls, and properly treated water must be provided at each show by the person.
- All containers must be uniform within a class.
- Single Entries – Two (2)-quart drum bowls of uniform manufacture. Plastic tanks may be substituted for glass bowls.
- Tank Entries – Tanks or 2-quart bowls. If not enough are available to house all tank entries, one or more complete classes should be changed to 2-quart bowls or tanks.
- Breeder Class – Recommended to be shown in 2 or 3-gallon tanks.

Backgrounds:

Background, to include tank/bowl bottom, shall be of uniform dark material, and be consistent throughout all classes, including the Best of Show classes. Tanks and bowls should not be more than two (2) inches from the background, wherever possible.

Lights:

All fish are to be judged under the same lighting conditions. The type of light must be published by the show committee prior to the show, in the rules and regulations as well as the IFGA website. Auxiliary hand-held lights are not permitted during judging.

Water:

All water will be treated uniformly so that the water provided for each entry is the same. Any additives or chemical treatments provided shall be the same for each entry so that no advantage or disadvantage to an entry is provided by any treatment by the host club. Individuals benching their own fish are exempt. **(11/2012)** Should any exhibitor provide his/her own water, it must be free of any material, such as medication, which could distinguish their entry from any other.

SECTION V – JUDGING AND AWARDS

Judging Teams:

It is recommended that at least three (3) judges work together as a team. If possible, no more than one judge from one area of the country should be on a team.

Judges shall not judge their own fish or fish they have entered for another exhibitor.

All decisions of the judges shall be considered final.

Recommended Awards:

<u>Single entries:</u>	1 st place, trophy; 2 nd , 3 rd , 4 th places, ribbons or award cards.
<u>Tank entries:</u>	1 st place, trophy; 2 nd , 3 rd , 4 th places, ribbons or award cards.
<u>Breeders:</u>	1 st place, trophy; 2 nd , 3 rd , 4 th places, ribbons or award cards.
<u>Best of Show Singles, Tanks:</u>	1 st place, trophy; 2 nd , 3 rd , 4 th places, ribbons or award cards.

Shipment of Awards:

Each club shall absorb the cost of shipping its trophies by the most economical method. Shipping should be accomplished as soon as practical.

SECTION VI – CHAMPIONSHIP AWARDS

Point Accumulation and Computation

Points toward annual championship awards are accumulated throughout the show year by exhibiting members who place fish at the IFGA Point Shows. Points are accumulated toward the various championships, as follows:

- Color Class Championship: 1st through 4th place wins in specific color class awards
- Breeder Championships: Males – 1st through 4th place wins in the 5-matched male class count toward this award.
Females – 1st through 4th place wins in the 3-matched female class count toward this award.
- Grand Overall Male: 1st and 2nd place wins in all male classes including Breeder Male and all Male Best of Show categories count toward this award.
- Grand Overall Female: 1st and 2nd place wins in all female classes including Breeder Female and all Female Best of Show categories count toward this award.

Championship Points won at a show are computed by multiplying the basic points times the point value of the show. For a 10 Point Show, multiply the basic points times 10.

Basic Points

Single Entries	Breeder Males	B.O.S. – Single	All-Color Veil Entries	B.O.S. – Female
1 st pl – 10 pts	1 st pl – 20 pts	1 st pl – 30 pts	1 st pl – 10 pts	1 st pl – 20 pts
2 nd pl – 8 pts	2 nd pl – 15 pts	2 nd pl – 24 pts	2 nd pl – 8 pts	2 nd pl – 16 pts
3 rd pl – 6 pts	3 rd pl – 10 pts	3 rd pl – 16 pts	3 rd pl – 6 pts	3 rd pl – 12 pts
4 th pl – 4 pts	4 th pl – 5 pts	4 th pl – 10 pts	4 th pl – 4 pts	4 th pl – 8 pts
Tank Entries	Breeder Females	B.O.S. – Tank	Novice & Junior/Sword Veil	
1 st pl – 20 pts	1 st pl – 15 pts	1 st pl – 50 pts	1 st pl – 5 pts	
2 nd pl – 16 pts	2 nd pl – 12 pts	2 nd pl – 40 pts	2 nd pl – 4 pts	
3 rd pl – 12 pts	3 rd pl – 9 pts	3 rd pl – 30 pts	3 rd pl – 3 pts	
4 th pl – 8 pts	4 th pl – 6 pts	4 th pl – 20 pts	4 th pl – 2 pts	

Penalties: A violation of IFGA rules and regulations by an exhibitor will result in a loss of all points accrued at a show where the violation takes place. If a violation is suspected, it will be investigated by the Board of Directors and the Judging Board. If these two bodies determine that a violation does exist, censure procedures will be determined by the Board of Directors. Further censure may be taken if deemed necessary by the Judging Board.

SECTION VII – IFGA ACCREDITED JUDGES

Judge Accreditation Requirements

A candidate must:

- 1) Attend two (2) IFGA seminars.
- 2) Observe at three IFGA sanctioned shows with a judging team.
- 3) Pass written test.
- 4) Judge five (5) guppies under controlled test conditions, and get a passing grade.
- 5) Assist two (2) qualified judges at five (5) IFGA sanctioned shows [three (3) for those in outlying areas).
- 6) Have approval of the Judging Board.

Assistant Judge Accreditation Requirements

A candidate must:

- 1) Attend two (2) IFGA seminars.
- 2) Observe at three (3) IFGA sanctioned shows with a judging team.
- 3) Pass the written test or must judge five (5) guppies under controlled conditions, and get a passing grade.

Judging Tests:

Any current IFGA Senior Judge may proctor the written test (to be graded by the Judging Board at any IFGA show. Visual tests of judging five guppies will only be given at an Annual Meeting/Show. Two senior judges must be present to administer a visual test which may be given with a seminar.

Judging Seminars:

A judging seminar for training those interested in learning about judging is held in conjunction with the IFGA Annual Meeting. In addition, any IFGA club hosting a sanctioned IFGA show may coordinate to allow a Senior Judge to present a seminar. All expenses are to be absorbed by the host club.

To Retain Accreditation:

Judges: A Judge must judge at least five (5) classes at a minimum of two (2) sanctioned shows in a two (2) year period, and attend a judging seminar every two (2) years to retain accreditation. Show Chairs are responsible for reporting any cases of judges not fulfilling the 5-class minimum at their show.

Additionally, all judges may be required to participate in a continuing education program every two years. Should a judge perform unsatisfactorily, he/she must satisfactorily complete a training session during that year (but no later than the next Annual) or be downgraded to assistant status.

Assistant Judges: An Assistant Judge must judge five (5) classes at one show each year, and attend one seminar every two (2) years. Participation in the continuing education program as described for judges above may also be required for assistant judges. If required, a failure will cause him/her to be dropped from the Assistant Judges List.

Miscellaneous: The judging year is defined as the year beginning with the Annual Meeting/Show, and ending with the show prior to the next Annual.

Loss of Accreditation:

When an accredited judge loses accreditation, he/she becomes an assistant judge. When an assistant judge loses accreditation, he/she loses all judging status and must begin the process all over again with nothing accomplished in the past counting toward accreditation requirements.

SECTION VII – IFGA ACCREDITED JUDGES (CONT.)

Reinstatement: If a judge loses accreditation, he may be reinstated after judging two (2) sanctioned shows within the next show year, attending one seminar, passing a written test and securing the approval of the Judging Board.

Censure procedures: Steps may be taken against a judge for just cause, such as judging their own fish, judging fish that they have entered for someone else, cheating, etc. Censured judges may be removed from the Accredited Judge List by the Judging Board. A formal complaint, in writing, at the time of the show must be presented to the Show Chairperson, who will turn the complaint over to the Judging Board for review. Fish will not be re-judged. Any censure procedure will be initiated by the Judging Board.

List of Accredited Judges: The names of the currently accredited IFGA judges are posted on the IFGA Web site (www.IFGA.org).

SECTION VIII – CHANGES TO JUDGING STANDARDS

All proposed changes to the judging standards must be submitted to the Judging Board, which will present its recommendations to the Board of Directors for a vote. Changes or additions to the Judging Rules are to be voted on only at the IFGA Annual Meeting, and will go into effect at the first show of the next show year.

SECTION IX – CLASSIFICATION OF ENTRIES

Color Strains: The background color of the body of the guppy is known as the color strain. The recognized color strains are as follows:

- Gray** Wild body color
- Gold** A minimum of 25% of a yellow gold color in the body.
- Albino** Any fish with red or pink eyes, regardless of the body or caudal color.
- Bronze** A dark (“old”) gold body with 25% (minimum) of darkly edged scales.
- Half-Black** Any basic color in combination with black from the dorsal back to the caudal fin. To qualify, at least 60% (**10/2015**) of the area (dorsal to caudal) must be a shade of black.

Classification for Show Entries: The following chart can be used to properly place your entries in an IFGA show.

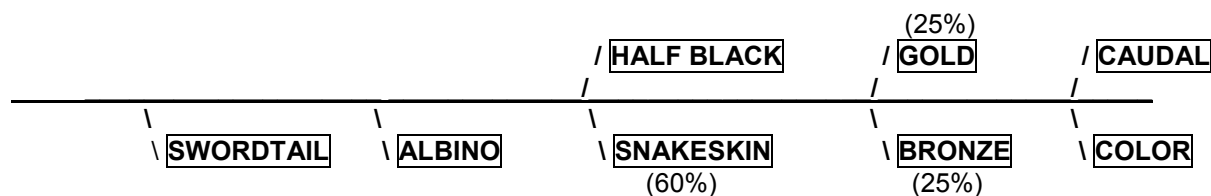

- Caudal Shape:** All male fish with sword-shaped tails, double or single, will fall into the Sword Tail Class, regardless of eye or caudal color.
- Eye Color:** All fish with pink or red eyes, except swords, will fall into the Albino Class.
- Body Colors:** Bronze and gold-bodied fish will be classified by the appropriate body color.
- Body Pattern:** Fish with half-black or snakeskin bodies will fall into these classifications. They may be further classified by caudal color within their body pattern class at the discretion of the individual show committees.
- All Color Veil:** All veils except Novice and Junior Veil/Sword will compete in this class.
- Caudal Color:** Remaining fish will be classified by the appropriate caudal color.

Color Varieties: The basic color strains may be further divided into color varieties with the color of the caudal fin denoting the color class. The colors should be pure and extend well into the body and dorsal. Preference is given to the most intense shade of color. The recognized colors are: Red, Green, Blue, Black, Multi, Yellow, Purple, Pastel, Bicolor, and AOC. (The AOC Class is for colors not covered by any particular class.)

Color Clarification:

- Bicolor:** A distinct variegated pattern of two different colors, or two obviously different shades of the same color, with at least 25% of the secondary color. Ideally, split 51%/49%.
- Multi:** Shall be three or more colors equally distributed basic colors in any pattern with at least 15% of the third color.
- Snakeskin:** Must have a distinct “chain-link” or rosette pattern over a minimum of 60% of the body. (The word “cobra” has been eliminated from the IFGA classification.) Fish displaying the vertical zebrinous bars (formally called “cobras”) without the snakeskin pattern will compete in the appropriate caudal color class.
- Pastel:** Shall be a light shade of any basic color, with the color white included as a pastel.
- Half Black:** A half-black body with the caudal color other than black will go into the appropriate half-black caudal color class. A half-black body with a black caudal will be in the Black Class. (50% minimum of the peduncle must be a shade of black.)
- Gold:** Will be defined by basic body color (25% yellow gold color)
- Half-Black Gold:** Will be in the Half-Black Class (same half-black definition)
- AOC:** Will be any color not covered by recognized show classes.
- Females:** Must show a gravid spot and must not have a gonopodium. Color of the caudal shall denote the color class, except for gold, albino, or bronze.
- Half Black Females:** Half-Black females with black caudals will be entered into the Black Female Class. Half-Black females with other than black caudals go into the Half-Black Female Class.

Classification by Caudal Shape: See individual standard outlines for classification by tail shape.

SECTION X – POINT SYSTEM FOR JUDGING

Point System for Judging Males:

	<u>BODY</u>	<u>DORSAL</u>	<u>CAUDAL</u>
Size*	8	8	11
Color	8	8	11
Shape	5	5	10
Condition	<u>4</u>	<u>4</u>	<u>5</u>
	25	25	37

Department: +5
Symmetry: +8

TOTAL POINTS = 100

*The points awarded for size will be the total area of the fish in proper proportion.

Tank and Breeder Entries: Add 10 points per fish for similarity.

Disqualifications: Fish entered into the wrong class will be disqualified. Color, tail shape, fish failing to meet reasonable size requirements, or fish dead on the bench will be considered disqualifying characteristics. Disqualification decisions require a unanimous decision of the judging team (3 judges). They will be indicated by a tag affixed to the entry, marked as such on the judging card, and turned over to the show committee.

Point System for Judging Females:

	<u>BODY</u>	<u>DORSAL</u>	<u>CAUDAL</u>
Size*	11	7	11
Color	4	6	11
Shape	11	4	10
Condition	<u>4</u>	<u>3</u>	<u>5</u>
	30	20	37

Department: +5
Symmetry: +8

TOTAL POINTS = 100

* The points awarded for size will be the total area of the fish in proper proportion.

SECTION XI – JUDGING STANDARDS FOR TYPES OF GUPPIES

THE DELTA TAIL GUPPY

Body: The body to caudal fin ratio shall be one to one (1:1.) The caudal peduncle proportions are to be 3 units in length to 2 units in height (3:2), and strong enough to support the caudal fin. The body is to be well rounded, and not humped or flat headed.

Dorsal Fin: The dorsal fin will be of a parallelogram shape, with a proportion of 3 units in length, to 1 unit in height (3:1), and be held erect.

Caudal Fin: The caudal fin shall form a triangle into the caudal peduncle, with a spread of between 55 degrees to 75 degrees, 60 degrees to 70 degrees being the ideal. The posterior edge of this fin is to be even or fringed, and not scalloped or frayed. This fin is to be spread wide and carried erect at all times.

The caudal angle for both delta and veil are determined by the angle formed from the trailing edge of the caudal into the body (as per second diagram below). Rays that are either lacking or extended beyond this angle are to have point(s) deducted for caudal shape.

Color: The dorsal, caudal, and body should be the same color. More intense colors with good density are better than drab colors.

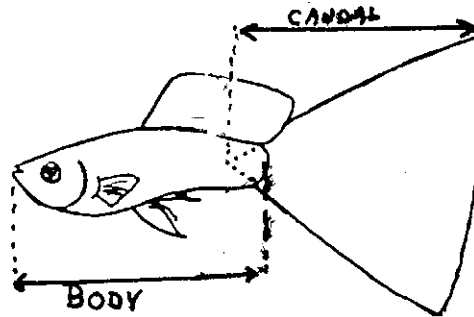

Delta Tail: The above figure shows the method used to measure the length of the body and the caudal fin to obtain optimum proportion.

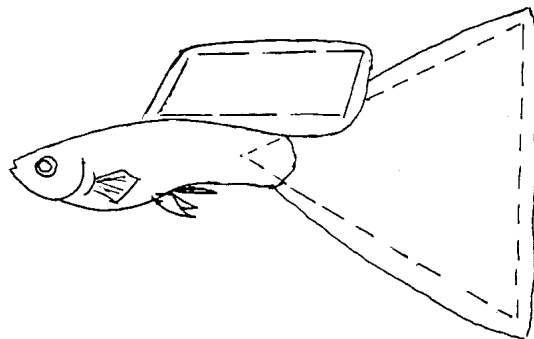

This figure shows a parallelogram superimposed over the dorsal fin, and a triangle over the caudal fin extending into the caudal peduncle.

SECTION XI – JUDGING STANDARDS FOR TYPES OF GUPPIES (CONT.)

THE VEIL TAIL GUPPY

Body: The body to caudal fin ratio shall be one to one (1:1.) The caudal peduncle proportions are to be 3 units in length to 2 units in height (3:2), and strong enough to support the caudal fin. The body is to be well rounded, and not humped or flat-headed. The figure on the previous page for deltas illustrates the same concept and method used to measure the length of the body and the caudal fin to obtain the same **optimum proportion in veils.**

Dorsal Fin: The dorsal fin will be of a parallelogram shape, with a proportion of 4 units in length, to 1 unit in height (4:1), and be held erect.

Caudal Fin: The caudal fin shall form an isosceles triangle into the caudal peduncle, with a spread of between 40 to 50 degrees, with 45 degrees being the ideal. The posterior edge of this fin is to be even or fringed, and not scalloped or frayed. This fin is to be spread wide and carried erect at all times.

As noted on the previous page, the caudal angle for both delta and veil are determined by the angle formed from the trailing edge of the caudal into the body. Rays that are either lacking or extended beyond this angle are to have point(s) deducted for caudal shape.

Color: The dorsal, caudal, and body should be the same color. More intense colors with good density are better than drab colors.

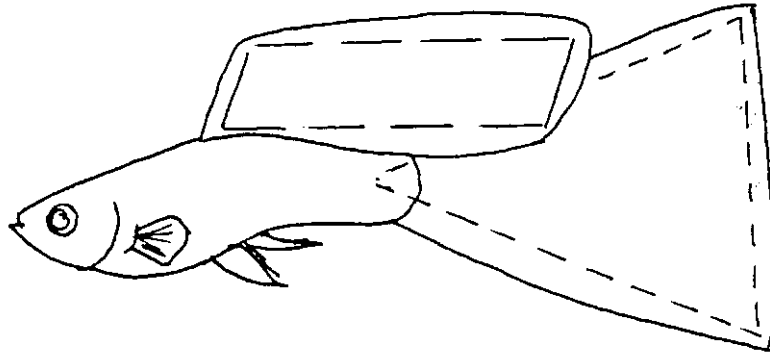

This figure shows a parallelogram superimposed over the dorsal fin and an isosceles triangle over the caudal fin extending into the caudal peduncle.

SECTION XI – JUDGING STANDARDS FOR TYPES OF GUPPIES (CONT.)

THE SWORDTAIL GUPPY

Body: The body to caudal fin ratio shall, at a minimum, be one to one (1:1.) The caudal peduncle proportions are to be 3 units in length to 2 units in height (3:2), and strong enough to support the caudal fin. The body is to be well rounded, and not humped or flat-headed.

Dorsal Fin: The dorsal fin shall be long and narrow in the proportion of at least 5 units in length to 1 unit in height and to reach well beyond the caudal peduncle section.

Caudal Fin: Top Sword: The caudal fin shall form a sword-like extension of its upper rays.
Bottom Sword: The caudal fin shall form a sword-like extension of its lower rays.
Double Sword: The caudal fin shall form sword-like extensions of its upper and lower rays and be of equal length. The sword-shaped caudal fin extensions should have even tapers and not be club-shaped or frayed.

Color: The caudal and dorsal fins are to be the same color, or as close to one color or pattern as possible. There must be a clear area between swords. A male with total color in this area will be disqualified from the swordtail class.

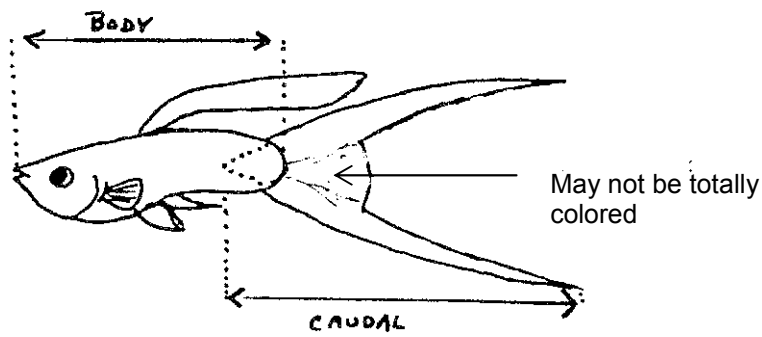

Sword Tail: The above figure shows the method used to measure the length of the body and the caudal fin to obtain optimum proportion.

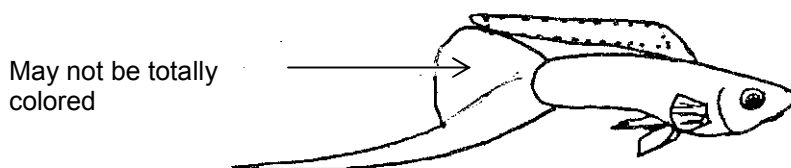

This figure shows a parallelogram superimposed over the dorsal fin.

SECTION XI – JUDGING STANDARDS FOR TYPES OF GUPPIES (CONT.)

THE FEMALE GUPPY

Body: The body to caudal fin ratio shall be two to one (2:1) or of proportions that show good symmetry. The caudal peduncle is to be of proportions strong enough to support the caudal fin. The body is to be well rounded, and not humped or flat-headed. The anal fin should be well rounded. A gravid spot must be visible.

Dorsal Fin: The dorsal fin shall be in proportion to the caudal fin size, i.e. a large caudal/a large dorsal fin.

Caudal Fin: The posterior edge of this fin is to be even and not scalloped or frayed. This fin is to be spread wide and carried erect at all times.

Color: The dorsal fin should preferably show the same color as the caudal fin.

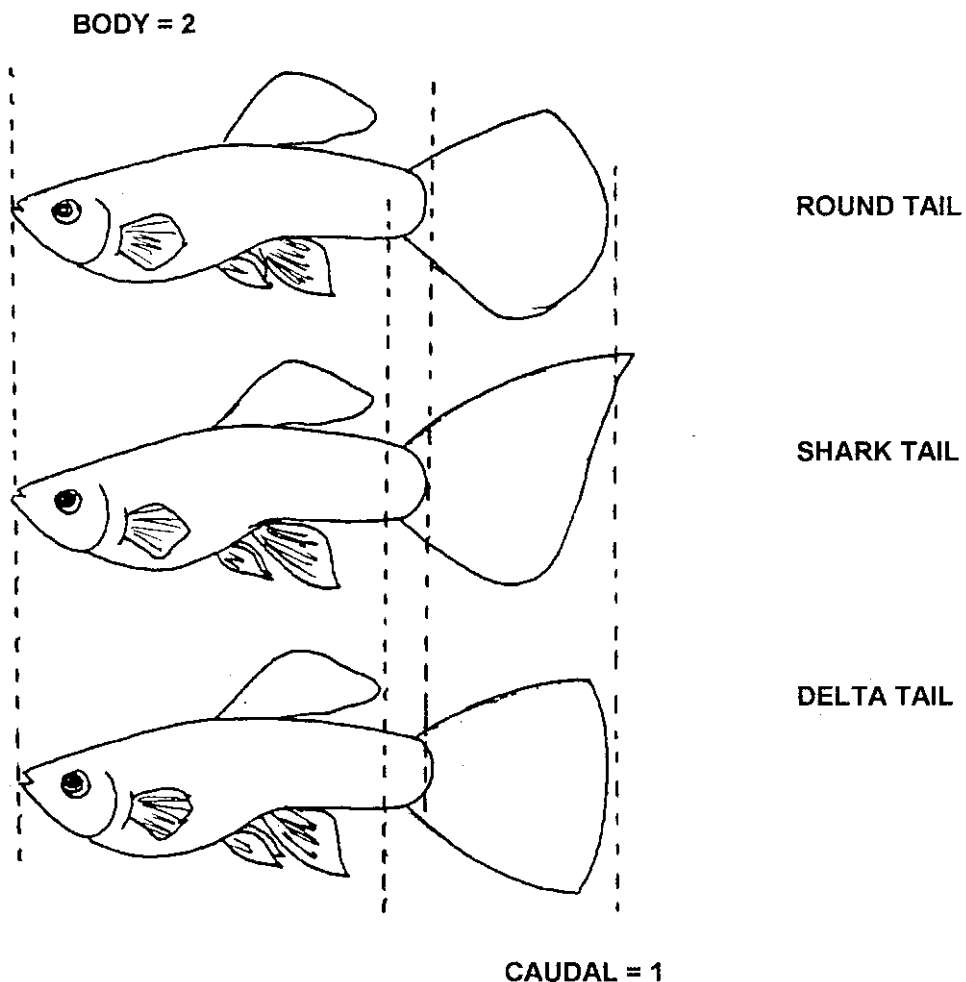

These figures show the method used in measuring the length of the body and the caudal fin to obtain the proper proportions.

SECTION XII – JUDGING THE MALE GUPPY

STAN SHUBEL'S JUDGING ARTICLES WERE ORIGINALLY PUBLISHED IN THE IFGA BULLETIN, AND WERE CONSIDERED A BIG HELP IN TRAINING JUDGES. IT WAS SUGGESTED AT THE 1972 ANNUAL MEETING THAT THESE ARTICLES BE INCLUDED WITHIN THE "JUDGING RULES AND STANDARDS BOOKLET." WE HAVE ATTEMPTED TO MAKE THE PROPER REVISIONS, WITH STAN'S HELP, AND WITH FOOTNOTES BY MIDGE HILL. ADDITIONAL CHANGES HAVE BEEN INCLUDED IN THIS EDITION. THIS CURRENT EDITION IS UP TO DATE FOR DISTRIBUTION IN 2008.

JUDGING GUPPIES

BY STAN SHUBEL

JUDGING THE BODY (MALE)

In this the opening segment of a series on judging guppies, I will cover the points allocated for the body. You will note that when checking over the point system, that in certain areas the point difference is not too great. However, when it is taken into consideration that generally, the top four places in a class have only a three or four point spread between first and fourth place fish, each point becomes important. Therefore, for judging purposes, as well as for placing in a show, you should know the point rules as thoroughly as possible.

Body Size (8 Points)

The size points should be determined first, followed by points for shape and condition. I may have to go to extremes for clarification purposes. At this time, generally speaking, a fish with a 1¼" body would receive 8 points for body size. A 1" body, 6 points. A 7/8" body would get 5 points, etc. A judge would be wise to make him/herself proficient in estimating measurements in relation to body size, it not being practical to put a pair of calipers into the tank.

When judging, you will come up again an occasional mule, and after throwing up your hands and saying, "What on earth do I do with this?" you would judge it as it is, more than likely giving it maximum body size points. But unless it has proper conformation, there is very little chance of its placing.

It would be nice to say that all you have to do is read the judging rules, attend a couple of seminars, judge a few shows, and you are a good judge. However, that just doesn't work. No matter how good you are on the theory, it takes a lot of practical experience to make a top judge. When you judge fish, you should always be prepared to explain to an exhibitor why you judged the fish as you did.

Body Shape (5 Points)

In judging the shape of the male guppy, the body should be well rounded and not humped or flat headed. There should be no ridges or depressions behind the eyes. The fish, when viewed from the top, should be straight and not have any lumps or curvature of the spine.



GOOD SHAPE



RIDGE BEHIND
THE EYE

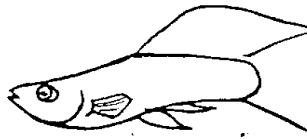

FLAT HEAD
TO DORSAL



THIN BODY

The peduncle should be 3 units in length to 2 units in height and strong enough to support the caudal fin. The body length should be in proportion to the depth. The paired fins should be the same shape and size.

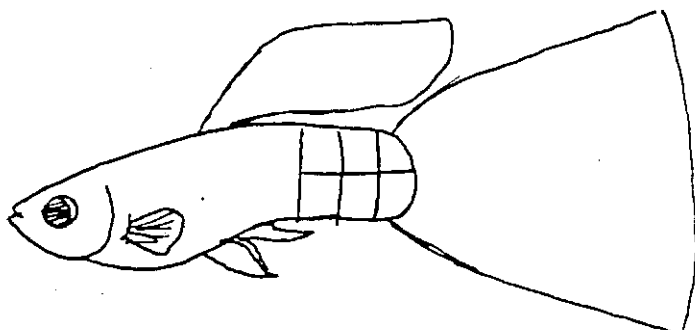

2 Units High

3 UNITS LONG

As to the actual point: a minimum of at least 1 point must be given for body shape. A fair body shape would receive 2-3 points. A good body shape would get 4 points. Only an exceptional fish would receive 5 points. In judging, always leave yourself room for improvement.

Body Condition (4 Points)

Going next to the condition points, again follow the same outline. The body must be free of disease with no scales missing. The eyes should be clear and normal; the gill plates should be well developed and equal. A minimum of 1 point must be given. For a fair fish, give 2 points, for a good fish, you would give 3 points. (Not much of a spread, but they could be the difference between placing or not.)

Body Color (8 Points)

Body color, except in a few cases, will be determined by caudal color. By this, I mean that a fish with a blue caudal and a blue dorsal should have a blue body. This would be the ideal blue class fish. For purposes of identification, we will use the terms "*Density*" and "*Intensity*". Please forget the dictionary for a few minutes. *Density* will mean the amount of color in a given area. *Intensity* will be the brightness of the color in a given area.

Of the total of 8 points for body color, allow 4 points for density, and 4 points for intensity. The following illustrations will be for the *density* scale or amount.

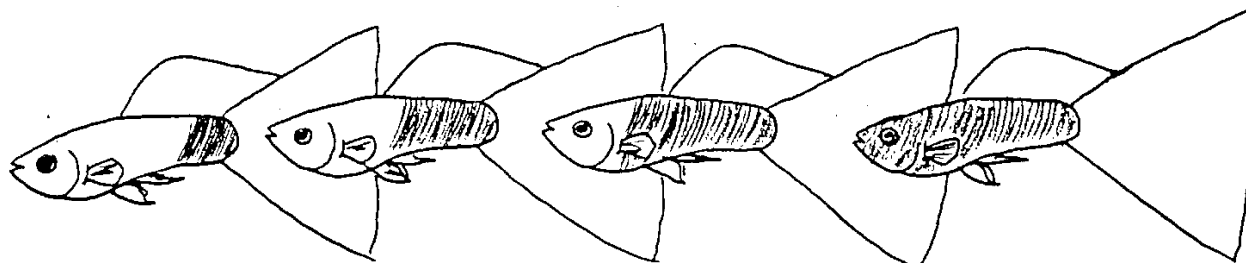

1 POINT

2 POINTS

3 POINTS

4 POINTS

The following will be for *intensity* or brightness of the color. The drawing shows a fish with a 3-point density scale, and a 2-point intensity scale. In other words, the fish has a degree of color in 75% of the body area, but the color is bright in only 50% of the total body area, so it would receive 5 points for body color when density and intensity points are added together.

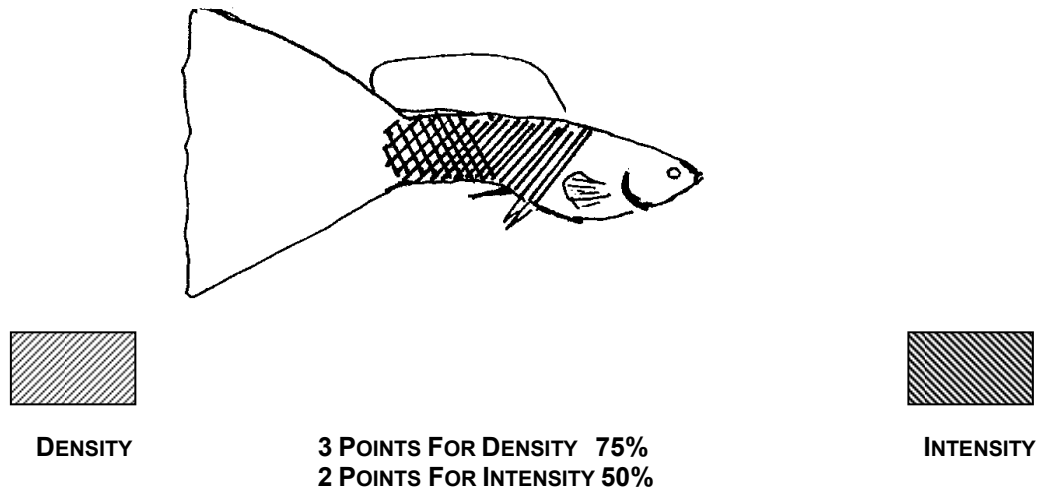

In dealing with the patterned type of body, such as the snakeskin, the same would hold true except the density portion would be an unbroken chain link or rosette pattern with points taken off for a broken or splotched pattern. Color intensity points would be the same as above. The background body color (intensity) should be the same as the caudal color.

For the half-black body type, the color pattern would be a clearly defined line from below the dorsal fin to the bottom of the body. The color should be of a jet-black intensity and should divide the body in half. In a red-tailed half-black class, the ideal fish would have a clear red tail, clear red dorsal, clearly defined half-black body with the front portion of the body red.

In the half-black class, a $\frac{3}{4}$ black fish would not get extra points for body color because of the increased degree of blackness. In all black classes, this would be a different story; in this case, you would be looking for an all black body.

Years ago, we used to have some people enter the same type of fish in several different classes, and because points for size were so important, these fish would place even though they were improperly classified. Now it no longer happens that way. For instance, suppose a giant black fish were entered in the blue class and this fish was perfect.

All you would do is give it 1 point for body color, 0 points for dorsal color, and 1 point for caudal color, and no way could this fish win. In essence, this would be the same as disqualifying an improperly classified entry.

Often we run into problems at the show in the gold and bronze classes. People seem to feel that if a fish came out of gold parents, for example, the fish is automatically a gold, even though it does not have a true As I have mentioned before, a silvery-grey color is not gold. Nor in the bronze class is a fish with a dark grey-gold body without the black edged scales a bronze. You can only judge what you see. It would be the same as saying a green fish out of red parents would be red because it is from a red strain.

Note on Body Deformity

Up to 10 points may be deducted for body deformity. The degree of the deformity would determine the number of points. A judge should be very critical in this area. An eye missing, gill plates missing, crooked spine or pot bellied to the extreme or severely humpback would be considered major deformities; again the degree would determine the amount of penalty. Ten (10) points should be deducted for a clipped gonopodium, which is to be considered a deformity.

JUDGING THE DORSAL (MALE)

Many Exhibitors are now realizing how important the dorsal is. Generally speaking, no matter how large or well-colored the body or caudal is, unless the dorsal is good the fish's chance of winning is very slim.

Shape (5 Points)

The shape of the dorsal will depend on which type of tail you are judging, as shown in the figures below:

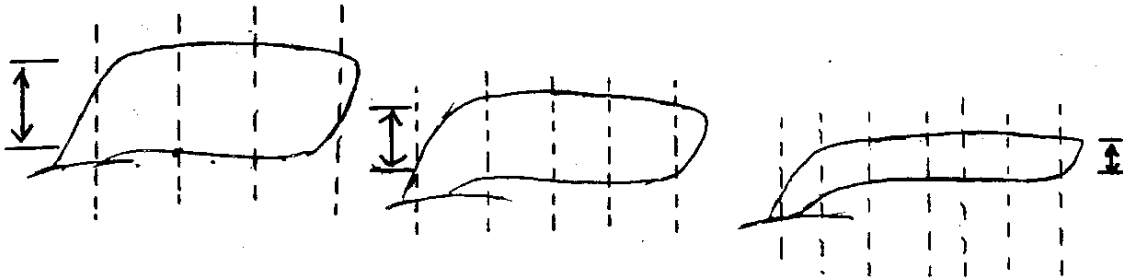

The Delta Dorsal should be a parallelogram of 1 unit high by 3 units in length.

The Veil Tail Dorsal is a parallelogram of 1 unit high and 4 units in length.

The Swordtail Dorsal should be 1 unit high and at least 5 units in length. The rules call for this dorsal to be long and narrow and to reach well beyond the caudal peduncle section. Usually it is shaped like the caudal itself.

If the dorsal does not meet the class requirements, shape points would be taken off. For a poor shape, 1 point would be given. For a fair shape 2 or 3 points would be given. A good shape can be awarded 4 points. Only an excellent dorsal would receive 5 points.

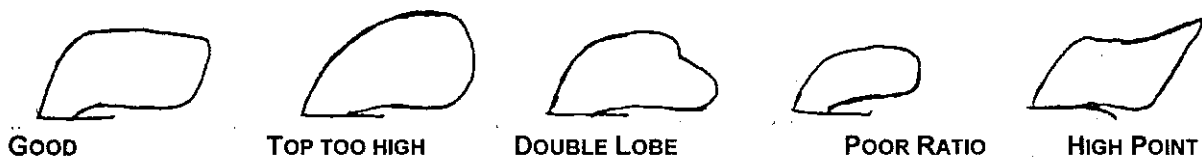

Size (8 Points)

Size involves somewhat of a different factor. The dorsal may be of good shape with the required number of total units and still fall short in size. Size points would be determined by total area of the dorsal, as in the illustration below.

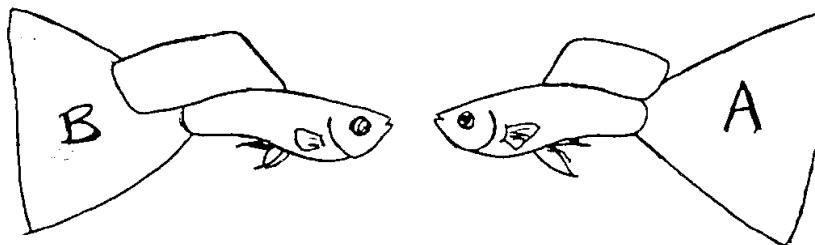

Both of the above would receive approximately the same shape points, but fish "A" would receive 4 points for size and fish "B" would be awarded 8 points, having twice the total area of dorsal, but still with the required units for shape.

Most fish, especially those with the large, flowing type dorsal, do not normally display them too well. Therefore, extreme time and care must be taken to determine their correct shape, size and condition. If you thought the body was hard to determine size on, wait until you try measuring the dorsal.

Size points are broken down as follows:

- The Delta Dorsal calls for 1 unit in height to 3 units in length. For an 8 point dorsal, the size should be approximately $\frac{5}{16}$ " in height, by $\frac{15}{16}$ " in length. A dorsal of $\frac{1}{2}$ " in length, with the appropriate height, would receive 4 to 5 points.
- With the Veil Dorsal, generally it is not quite as high as the delta dorsal, being between $\frac{1}{4}$ " and $\frac{5}{16}$ " in height. It calls for a 1:4 ratio. Maximum size points would be given for a $1\frac{1}{4}$ " size. A $\frac{5}{8}$ " dorsal would again receive 5 to 6 points if in proportion.
- The Swordtail Dorsal, as I mentioned before, will seldom reach a $\frac{1}{4}$ " height, being closer to $\frac{3}{16}$ ". Usually the ratio will be 6 or 7 units in length, to 1 unit in height. A fish with a $1\frac{1}{4}$ " dorsal would receive close to maximum points for size.

When awarding size points, remember they are given for total area of dorsal in the proper units of measurement.

Color (8 Points)

With a total of 8 points being allocated for color, the breakdown would in essence be the same as with the body. Using the terms density and intensity (amount of color and brightness of color as explained in body color), the color points would be given as illustrated below:

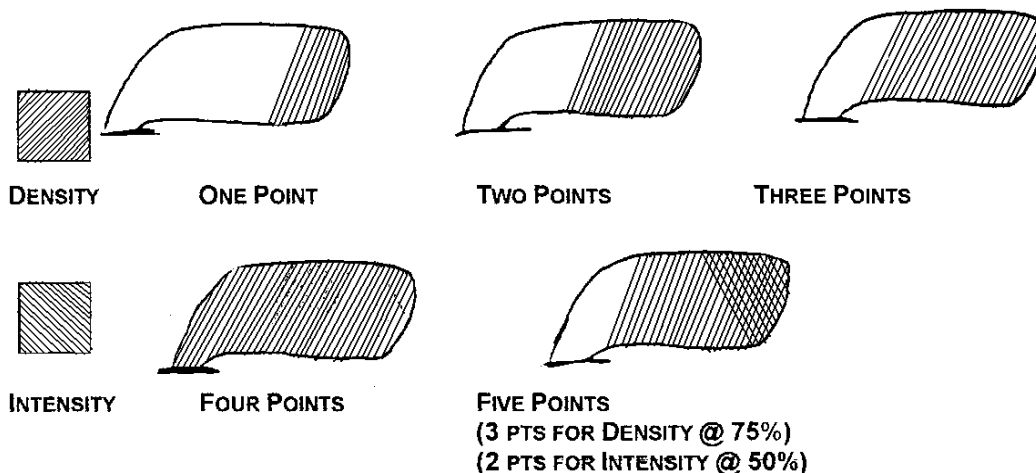

One good thing about judging color points in the dorsal is that the color pattern should always be the same as the caudal. The above points would apply only if the dorsal color matches the caudal. If the dorsal color is clear or does not match the caudal color at all, then zero color points would be given.

Condition (4 Points)

Condition points take into consideration any rays sticking out of the sides. All edges should be of a smooth nature, with the corners slightly rounded. It should be disease free and have no splits.

We have 4 condition points with which to work. A poor condition would receive the minimum of 1 point. A fair condition dorsal would receive 2 points, a good condition dorsal would get 3 points. An excellent condition dorsal would receive 4 points. Not a large spread, but a point will often make the difference between placing or not.

JUDGING THE CAUDAL (MALE)

We now come to one of the most important areas in judging. Not only are more points allocated for the caudal, but generally speaking, here you will determine which class the fish will go into.

Once it has been determined that the fish you are judging is a male, you will deal with three basic tail shapes: Delta, Veil, and swordtail. Thankfully, we are now able to disqualify fish improperly classed. In the past it was all too common to see half of the veil classes filled with poor deltas, and many times winning. With the improvement of our judges, along with the new rule regarding disqualification for improper color and tail shape, the shows should improve greatly.

Shape (10 Points)

First, we will consider the shape of the caudal. The following illustration shows the various tail shapes for the male.

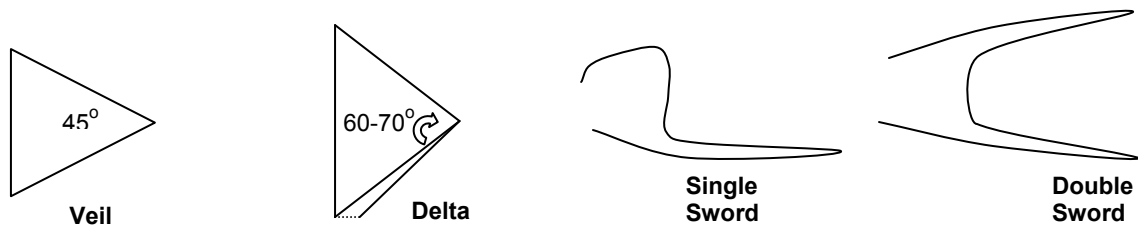

As you will note, on paper it seems quite easy to determine the difference between the veil, delta, and swordtail. In actual practice, it is not always so simple, especially in a moving fish.

I would seriously doubt if but a few people could determine a variance of less than 5 degrees, so it is up to a judge to familiarize himself with the difference in degrees of angles.

A simple and effective method is one that I will describe, and it may be used before, and during a show. Take a piece of square paper, fold it in half. The angle at the base as shown in Figure #1 is 90 degrees. If in turn you fold this paper from the points, as shown in Figure #2, you will have a 45-degree angle, or the veil tail shape. Now keep the 45-degree angle and divide the part that you folded over into thirds. By the addition of one of these thirds to the 45 degrees, you will now have 60 degrees or the minimum delta tail shape. See Figure #3.

Figure #1

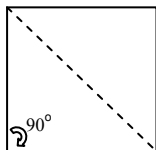

Figure #2

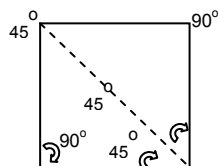
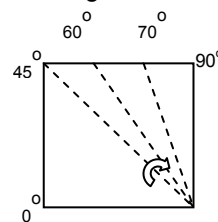

Figure #3



By the use of the above angles, you can solve many arguments. If the fish you are judging were properly classified, you would start pointing the fish. If the fish were entered into the improper class, they would be disqualified at this point.

This next may be somewhat of a new thought for many judges in regard to tail shape. For example, our standards call for an isosceles triangle of 45 degrees for a veil tail guppy. As far as it goes this is fine. However, in actual practice the breakdown would be somewhat as follows for shape points.

Take the total of 10 points for shape and allow 5 points for degree of angle and 5 points for overall shape. Through the illustrations below, I will attempt to clarify this. The veil spread is between 40 and 50 degrees, with 45 degrees being the ideal angle.

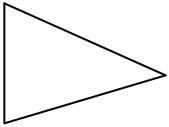
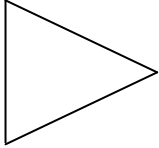
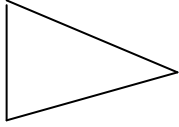
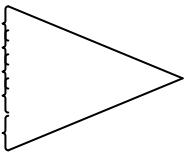
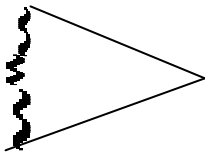
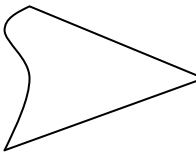
Degree of angle:	45 deg.	50 deg.	40 deg.
			
	4 – 5 points	2 - 3 points	2 - 3 points
Overall shape:			
	4 – 5 points	2 – 3 points	1 point

Anything above 50 degrees would be disqualified in the veil class, less than 40 degrees would receive 1 point.

Overall shape should be smooth or naturally fringed with no scallops, dips, or extended rays. By combining the degree of angle points with the overall shape points you will come up with the correct total shape points.

(Note that overall shape points would be the same for any male class.)

The degree of shape or angle points for the delta tail would be as follows:

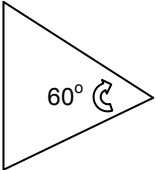
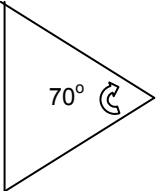
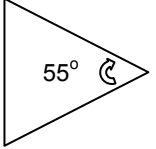
60 deg.	70 deg.	55 deg.
		
4 – 5 points	4 – 5 points	2 – 3 points

Anything below 55 degrees would be disqualified in the delta class. 75 degrees and above would receive 1 point for degree of shape.

As an example, we will take a delta tail and total the shape points.

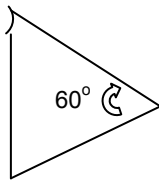

The degree of angle is 60 degrees, so we would give 4 points for angle.

The sides are even and smooth, but the back edge is not; 3 points for overall shape.

This would give us a total of 7 points for shape. As in judging all the areas, leave room for improvement.

Let's look at a Swordtail next, using a single sword for illustration.



8 – 10 points



5 – 7 points



3 – 4 points

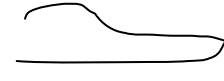

1 – 2 points

The sword should be an even taper, and not clubbed or blunted at the end. The edges should be smooth with no extended rays. The double sword should be an even taper and equal in length.

The caudal area behind the peduncle should be clear on a swordtail. Occasionally someone will try to put a trimmed delta or veil in the swordtail class.

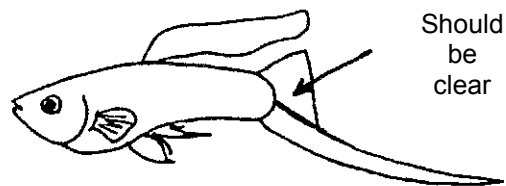

It is difficult to try to put across the actual shape of fish using illustrations. You will note the sides of the caudal are all even, when in actual practice it is seldom so. For me to try to depict the variances of the caudal with illustrations would only give you a more distorted view.

Take the angle charts down to your fish room and check over your fish. I think you may be somewhat surprised.

How to Judge Split Tails: Divide the caudal into four sections horizontally from the posterior to the peduncle area. If the fault is in the top section, no point will be given for that section. Give 1 point for each section, leaving 1 point for a perfect condition caudal. Tail condition is allocated 5 points.

NOTE: We have adopted a new technique for determining caudal shape. We no longer use the angle formed by the caudal rays as they depart the peduncle area, but in fact use the triangle overlays as depicted in this publication. The techniques on judging caudal angle using this approach will be covered in the seminars.

Color (11 Points)

In judging guppies, available light will have a great influence on the color that your fish displays. As we constantly try to improve the quality of our shows, light is becoming more of a factor than ever. It is recommended that before entering fish, the exhibitor familiarize him/herself with the type of light that will be used at the show. In this manner, it will be better able to determine the color classification of one's fish.

In awarding color points in the caudal, we will follow the same guidelines used in color judging the dorsal. Take the 11 points allocated for color and allow 6 points for density, and 5 points for brightness or intensity.

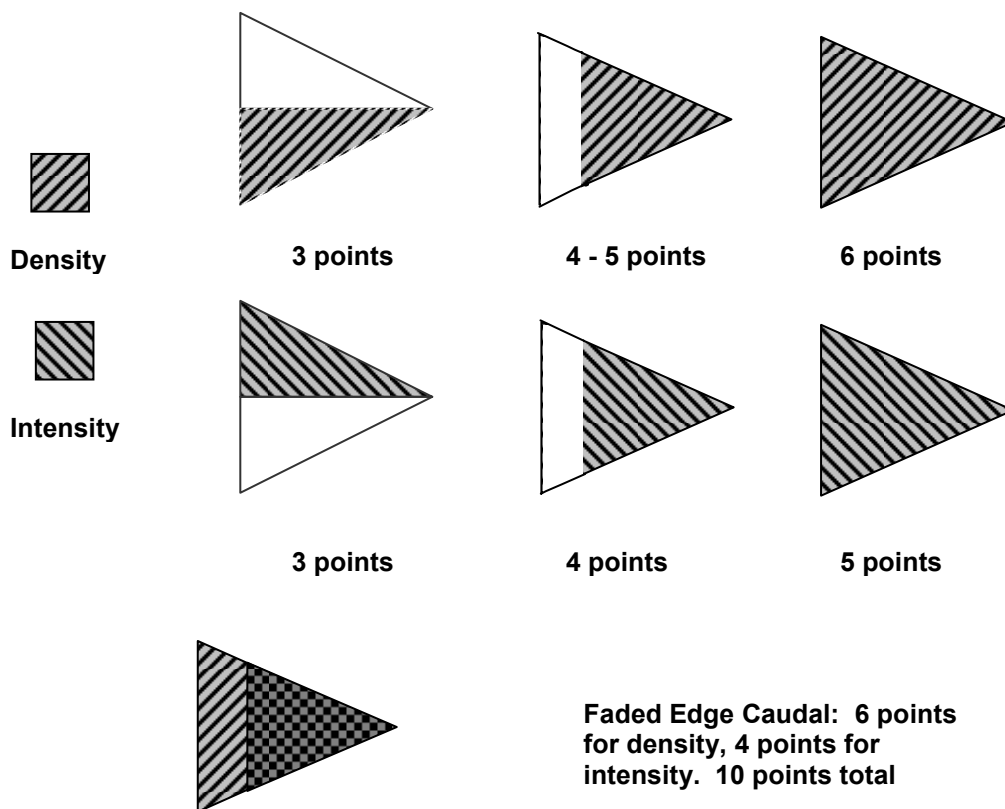

It should be noted that color points would only be given for the correct color in a given class. In other words, red spots on a caudal in the blue class will not be counted toward color points. This would be considered the same as absence of color in a given area.

As a further thought, a blue caudal may consist of several different shades of blue coloration. It would receive fewer color points than a solid color blue on one shade. The density factor may be the same in both fish, but the intensity would vary greatly.

In the Bi-Color class, the ideal would be 51% of the primary basic color, and 49% of the secondary basic color, with a minimum of 25% of the secondary color. Two distinct shades of the same color is also a Bi-Color fish. Very few true bicolor fish are seen at the shows.

A multi-colored tail would consist of three or more different basic colors, equally distributed in any random pattern.

Here again, as with shape, if the fish are improperly classified, disqualify them.

In a class such as Bronze, having no specified caudal color classification, equal points would be given for a red as opposed to a blue, depending of course, on the density and intensity factors, provided also, that both are true bronze bodied fish.

At a recent show, one fish, when viewed with a hand-held light from the top front angle, displayed green coloration. With the light held close to the top, it showed purple, and with the light held slightly to the side it looked blue. So, in essence, this fish, when viewed from three angles, as seen by a judging team, showed three different colors. This would seem to indicate that this type of light is not the last word in judging fish, at least for coloration.

The most controversial classes seem to be the Blue and Green classes. A safe estimate would be that at least 25% of the fish in each class are disqualified for improper color at every show. To combine the classes would make judging easier. However, there are blue fish, and there are green fish with a definitive color difference. The chore would seem to be to get the breeders to clarify their colors. A few are already doing this; more will follow as the judging gets sharper.

Size (11 Points)

In previous segments, we have covered the body, dorsal, and caudal shape. Size of the caudal was left for last. For here the 1:1 ratio factor comes into play. This may be somewhat difficult to understand for the beginning judge, but once understood, it makes judging guppies much simpler, and more accurate.

Going back to the body, we said that a male fish with a 1¼" body would receive close to the maximum of 8 points for size at this time. Using the following illustrations, we will match this fish with the proper caudal.

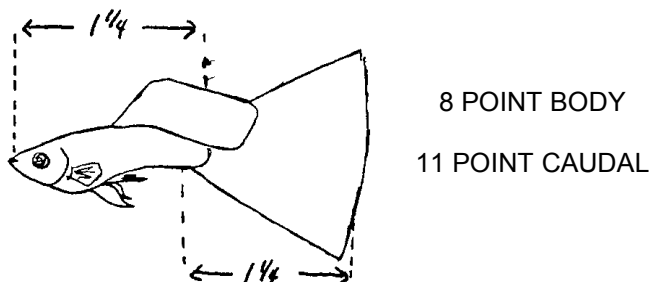

A further breakdown of size points in proportionate ratio would be as follows: (Starting with the body to which the caudal must conform in size.)

<i>(Approximate)</i> Body Size	Matching Caudal Size
1 ¼" 8 points	11 points
1 ⅛" 7 points	10 points
1" 6 points	9 points
7/8" 5 points	8 points
¾" 4 points	7 points
5/8" 3 points	6 points
½" 2 points	5 points

Generally speaking, at a show you will seldom go below a 2 point male guppy; if you do use the same proportional ratio on down.

The next illustration will show some out of proportion ratios:

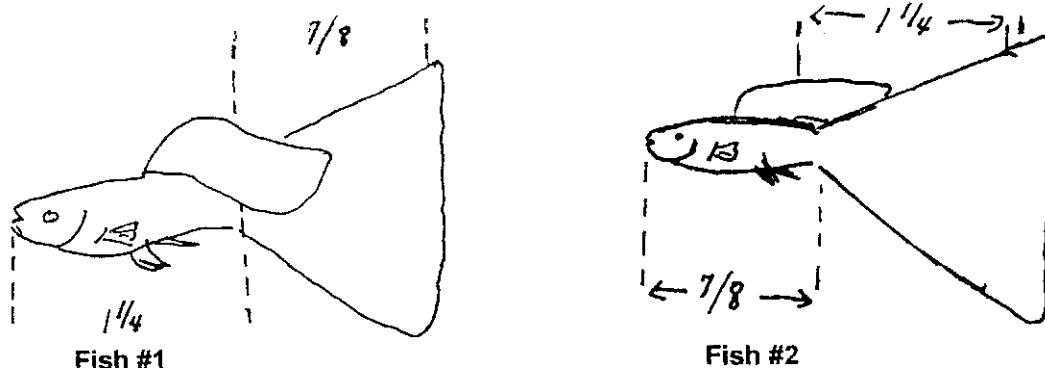

On fish #1 we have a $1\frac{1}{4}$ " body which would receive, for descriptive purposes, 8 points for size. The caudal is $\frac{7}{8}$ ", which is smaller than the required size. It would match a 5 point body, giving it an 8 size point factor (see chart). Deduct one point because the total area of the caudal is less than required. The fish would then receive a total of 8 points for body size and 7 points for caudal size, for a total of 15 points for these two factors.

REMEMBER: Size is determined by TOTAL AREA IN PROPER PROPORTION

On fish #2, we have a $\frac{7}{8}$ " body, which would receive 5 points for size. The caudal is large enough for a $1\frac{1}{4}$ " body so it is out of proportion ratio. A 5 point body calls for an 8 point caudal size (see chart). The total for fish #2 is 13 points. No additional points are given for the larger caudal.

As you will note, fish #1 received a total of 15 points for body and caudal size, while fish #2 received 13 points. All other factors (color, dorsal, etc.) being equal, you would go next to symmetry, which may be defined as follows: The overall pleasing proportions and balance of a fish in the proper ratio.

Whereas both fish are out of the 1:1 ratio, the larger caudal is slightly more desirable. Hence, fish #1 would receive 1 point for symmetry, and fish #2 would receive 3 points. Therefore, the two fish would tie with totals of 16 points. This would indicate that the too large body on #1 and the too large caudal on #2 are not desirable characteristics.

The next illustration shows a fish with a $\frac{7}{8}$ " body and a $\frac{7}{8}$ " tail. The following will describe how it would win over the other two fish by symmetry points, with all other factors being equal.

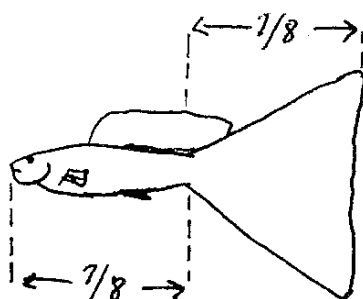

First, the $\frac{7}{8}$ " body would receive 5 points. The $\frac{7}{8}$ " caudal would receive 8 points, for a total of 13 points, which is 2 less points for size than fish #1 and equal to fish #2. But, by going to symmetry points, this fish, being in correct ratio (again with everything else being equal), you would give this fish 5 points for symmetry, thereby causing it to win over the other two fish with a total of 18 points, even though one fish has a larger body, while the other has a larger caudal.

As in all judging, try to retain at least 1 point for improvement, although you may occasionally need it to break a tie.

In summary, this is not an in depth study of judging, but merely an outline and guide. Where we allow only 8 points for an approximately 1¼” body, we give 11 points for a 1¼” caudal. If one were to take into consideration only the total points involved, it would seem out of proportion. But when you consider the total area (length and width), I am sure you will agree the caudal is much larger than the body, hence the extra points.

Just in case you are wondering about the tie between fish #1 and #2, it is up to the judge’s discretion to break a tie if the total point factors are the same. In this case, I would place fish #2 ahead of fish #1.

JUDGING DEPARTMENT & SYMMETRY (MALE)

Department (5 Points)

- How the fish swims and displays itself

Point Allocations

Bottom	1
Up but hanging	2-3
Swimming	4
Exceptional	5

Symmetry (8 Points)

- The overall pleasing appearance of a fish with the proper proportions and correct color balance

Point Allocations

Minimum	1
Poor	2 – 3
Good	4 – 5
Very Good	6 – 7
One in a Million	8

SECTION XIII – JUDGING THE FEMALE GUPPY

FROM ARTICLES BY
TOM ALLEN & STAN SHUBEL

CLASSIFICATION OF FEMALE GUPPIES

To be classified as a female, a guppy must show a gravid spot, and not sport a gonopodium. If in the agreement of the judges, a fish does not pass one or both of these requirements, it should be disqualified. Special care must be taken with some Black and Half-Black Females, as the gravid spot may not be readily visible and may blend in with the dark body color.

As with the male, one can quickly determine in which class a female belongs with the help of the following chart.

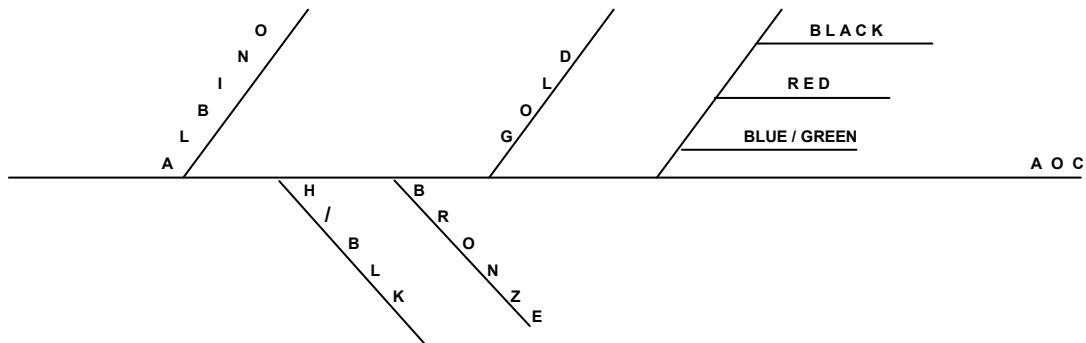

The half-black and gold are determined by body color, whereas in the final separation, caudal color is taken into consideration. If, however, there is an albino class, this is the first determining factor. A female must show 51% of the primary color to avoid disqualification. Obviously, the quality of lighting can be a determining factor in the amount of primary color at fish shows. Because a female is from a red strain does not necessarily mean she will pass the color test and not be disqualified.

From time to time confusion occurs on combined color classes such as the Blue/Green female. The slash sign separating the two colors implies that the fish can be blue, can be green, but need not be both blue and green. But suppose both blue and green were present? As long as the total percentage of all remaining colors is less than 49%, the fish should not be disqualified. However, these other colors are considered as an absence of the primary color and you would point down the fish accordingly, when considering color.

At a recent judging seminar, one of the participants asked where an Albino (red or pink eyes) female with a red caudal would be entered, if no Albino Female Class were available. Using the chart, we will see that she would have to be put into the red class. This is an unusual situation since one thinks of this class as being made up of gray bodied fish. Since she is not a half-black, not a gold and has at least 51% red in the caudal, she's a red. If she had 25% or more yellow gold coloration in the body, she would fall into the gold class, because the body color check takes precedent. When no Bronze Class is available, a bronze female would be classified according to the caudal color also.

To avoid being redundant, guidelines, definitions, etc., which are discussed in the chapters on judging the male, will not be repeated here. It is recommended that you review these chapters on judging the male, in the preceding pages before continuing with this article.

JUDGING THE BODY (FEMALE)

BODY SHAPE (11 Points)

Because of its major importance in the overall scheme, body shape as a judging category in the female has been given an additional 6 points over the body shape in the male. Unfortunately, at times we tend to be too lenient and place badly shaped females higher in the results than they should be. Let's fact it, an 8 or 9 point loss because of poor body shape should definitely keep a fish out of the running. Occasionally, you are asked to judge a female who is obviously "too pregnant", having a body so distorted it looks like a ball bearing with a tail. This fish would score low in body shape. The opposite condition is also possible, that is the female's body depth (thickness) may not be in proportion to her length, also scoring low shape points. You should also pay close attention to the peduncle area (again, not in a pleasing proportion to the shape of the body) would be reason to dock the fish in shape points.

Any female having an excellent shape would receive 9 - 10 points, a good shape, 7 - 8 points; fair shape 4 - 6 points; poor shape 1 - 3 points. The 11th point is held back for the exceptional fish. Any shape would get the minimum of 1 point. Note that it is still possible for two females each with a fair shape to still be 2 points apart. It is quite probably that any fish receiving low body shape points would also score low in symmetry (the overall pleasing appearance of the fish) as a poorly shaped body certainly isn't pleasing to the eye. Most show females fall into the 4-8 point range in body shape.

BODY SIZE (11 Points)

Judging body size on a male fish has become virtually routine since the establishment of the "size point" relationship. The same sort of relationship can be set for the female as is outlined in the table below:

	<u>Size</u>	<u>Points</u>
Over	2 1/4"	11
	2 1/4"	10
	2 1/8"	9
	2"	8
	1 7/8"	7
	1 3/4"	6

For females less than 1 3/4", you would down-point accordingly. If 2 1/4" seems extremely large compared to the 1 1/4" standard set for males, just remember that 1) females overall are larger than males and 2) we are developing a standard.

It is altogether possible that the male standard will have to be increased due to the large number of show fish approaching the maximum size. Probably the most appropriate meaning of the word "standard" is ideal, for which all breeders should strive.

BODY COLOR (4 Points)

For the most part, female body color is non-existent. For this reason only 4 points are available. Regardless of the number of points, we still use the density and intensity technique of assigning points. Only a female with exceptional color would receive 4 points; good color, 3 points; fair color, 2 points, and little or no color, 1 point. If we consider the fish being shown today, virtually all would receive minimum body color points, with the possible exception of blacks, and occasional red. Take note that the half-black must have enough black body color, and the gold enough yellow gold color for class determination.

BODY CONDITION (4 Points)

Excellent body condition would warrant 4 point; 3 points would be given for good body condition; 2 points for a fair condition, and 1 point as a minimum. Seldom would you give a fish anything other than a 2 or 3.

JUDGING THE CAUDAL (FEMALE)

Caudal Shape (10 Points)

Our standards on the female caudal recognize three widely differing shapes, namely: the Round, the Shark Tail, and the Delta Tail. To receive high shape points, the female caudal must compare favorably with our perception of an ideal caudal. The round tail should have smooth rounded corners, while the corners on the delta tail should be squared off much like the caudal on a male delta caudal. Rounded edges may also be evident on the shark tail. The most common fault is the incomplete formation of the lower quarter of the caudal as illustrated below.

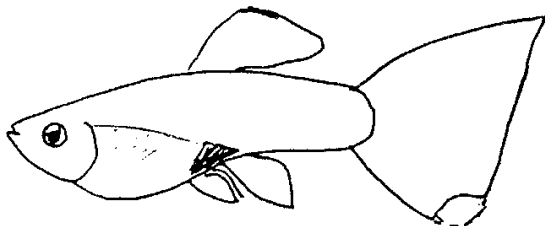

No guidelines as to the spread (in degrees) can be given due to the diversity of shapes. We would divide the allotted points as follows:

<u>Points</u>	<u>Shape</u>
10	Exceptional
8 - 9	Excellent
5 - 7	Average/Good
2 - 4	Poor/Fair
1	Minimum

Caudal Size (11 Points)

To determine the correct proportion, our current standards call for a female to have 1 unit of caudal length for ever 2 units of body length. We define caudal size as being the overall size of the tail within proper portion. At one time, our standards called for a body to caudal ratio of 3 to 1. Because of selective breeding, we began to see females in our shows whose caudals were far too large, and no longer the correct proportion. Caudal size translates as shown on the chart below.

	<u>Size</u>	<u>Points</u>
Over	1 ¹ / ₈ "	11
	1 ¹ / ₈ "	10
	1"	8 - 9
	⁷ / ₈ "	7
	³ / ₄ "	5 - 6
	⁵ / ₈ "	4
Under	¹ / ₂ "	2 - 3
	¹ / ₂ "	1

Female caudal size is always judged in relation to the size of the body. This is due to our strong emphasis on proportion and balance. Most females being exhibited today lack the proper proportion. Many breeders cannot understand how the standards can be so different from the actual fish being shown. You must keep in mind that standards are really meant to be goals, goals toward which we should breed. Continually changing the standards would cause severe havoc because so much of what we see in guppies is cyclical, down one year, and up the next. Our standards are one of the real strengths of our organization.

Consider the example of a female with a 2" body, and a $\frac{3}{4}$ " caudal, being judged against a more proportional, ($1\frac{1}{4}$ " body with a $\frac{3}{4}$ " caudal) but smaller fish. You would give the first fish 8 points for body size and 4 points (5 minus 1, for having less than the required caudal size) resulting in a total of 12 points. It would appear at this point that the proportional fish would lose since she would receive only 4 points for body size and 5 points for caudal size giving her a total of 9 points. You will see in a later section that the symmetry or balance of the fish will reverse this outcome.

Caudal Color (11 Points)

The 11 points allocated to color will be split by giving 6 points for density, and the remaining 5 points for intensity. Often times, for example, in the Red Class, we come across caudals with clear areas, dark spots, or other abnormalities of the primary color. These are to be considered as the absence of color, and the fish should be docked according to the degree. Any fish having a minimum (51%) of color can score no higher than 6 points. Actually, 6 points is probably high when intensity of color is considered.

Caudal Condition (5 Points)

Split rays, tail rot, and general raggedness are typical of the female caudal condition problems we face as judges. However, if we abstractly divide the caudal into quarters (as is suggested we do with the male), and allot one point for each good section, we reduce this to a simple exercise. Remember to keep the 5th point as a kicker for that exceptional fish.

JUDGING THE DORSAL (FEMALE)

Dorsal Shape (4 Points)

The female dorsal should resemble the male dorsal in shape with a slight narrowing at the trailing end. The illustration below indicates how the 4 points would be allocated.



1 Point



2 Points



2 – 4 Points

Dorsal Size (7 Points)

A dorsal, in the proper shape, which reaches $\frac{3}{4}$ " in length, would be given the maximum 7 points. Were we to measure the height of this dorsal we would find it would come close to $\frac{1}{4}$ ". It becomes apparent from this, that about a 3 to 1 (length to height) ratio is desirable. A 2 to 1 ratio would merit only $\frac{2}{3}$ or about four (4) size points, and a 1:4 ratio would receive 1 to 2 points.

Dorsal Condition (3 Points)

With only 3 points to work with, we are in effect saying that any fault in a dorsal would automatically reduce the points available to the minimum of 1. The actual point spread would look like this:

<u>Points</u>	<u>Condition</u>
3	Exceptional
2	Good
1	Minimum

Dorsal Color (6 Points)

The basic requirement concerning color in the female dorsal is that it matches the caudal in density and intensity, while maintaining a similar pattern. Looking at the Red Class again, a female receiving only half of the 11 caudal color points (say 5 – 6) would be hard pressed to score more than a 2-3 in dorsal color. This would hold true only if a perfect match were evident. While it is technically possible, it is highly unlikely that you would come across a female with a more dense and/or more intense dorsal color than her caudal color. An off color or clear dorsal would receive zero (0) points.

Department (FEMALES) (5 Points)

Most times, by the time department is judged, the judges have bounced the bowls around so much, it is a wonder the fish are still alive. At any rate, a good judge will make mental notes of a fish’s department through the judging process. If we do, we can more fairly relate to the table below:

5 – Exception Movement	2 – Little Movement
4 – Good Movement	1 – No Movement
3 – Average Movement	

Symmetry (FEMALES) (8 Points)

Symmetry, as earlier defined, is the overall pleasing appearance and balance of the fish in the proper proportion. Balance does not imply that the fish must swim upright, but rather points to the proportional relationship of dorsal, to caudal, to body, in both size and shape.

Recalling our earlier example, and assuming the dorsal to be in balance with the rest of the fish, we would give the proportional fish (number 2) close to the maximum in symmetry, thereby placing it over the larger, but less proportional fish. The assignment of points would be as follows:

<u>Points</u>	<u>Symmetry</u>
8	Exceptional
6 - 7	Excellent
4 - 5	Average
2 - 3	Poor
1	Minimum

MATCHING POINTS

By Paul J. Gorski, Judging Board Chair

For thirty-plus years, we have been awarding matching points for entries, such as tanks – 2 matched males and breeders – 3 females, 5 males, to determine the final outcome of these competitions. We have left the awarding of these points up to the subjective judgment of the judges and it has worked fairly well. At the last Judging Board meeting, it was decided that the time had come to base these competitions on an objective criteria to hopefully eliminate the confusion associated with allocating matching points.

Remembering that we can award up to ten (10) points per fish for matching characteristics, we developed the following guidelines for matching points:

3 points	body
3 points	dorsal
4 points	caudal

The application of these criteria is fairly simple; let's take a tank competition as an example. Your team has selected two entries as being the ones from which a winning tank will come. We assume that the point allocation determined by the team is equal. Tank A is subjected to the 3-3-4 rule. You ask yourself: does the body of each fish match the other, and to what extent does or doesn't it? Let's say they match very well – award three (3) points. Use the same method to examine the dorsal. You see a slight difference in dorsal shape and only award a two (2). Moving on to the caudal, you see a bit of color variation in two of the caudals and award it a three (3).

Add these, $3 + 2 + 3$ to get a total of eight (8). Multiply this figure by two (2) (or more) to get sixteen (16) of the twenty (20) possible matching points. Repeat this process on the other entry and determine the point allocation awarded for matching. Assuming the two tanks were equal prior to this assessment, the difference in the matching points will identify the winner.

This process can be applied to any competition. You can point or plus/minus all entries to establish a benchmark and then move on to determine matching points.

While we do not attempt to establish hard criteria for judging, we do want to emphasize that an objective set of standards and procedures must be followed when judging all entries. The final decision, as always, rests in the ability of a judge to evaluate an entry against the established standards of the IFGA and not from his/her personal preference.